

FIG. 1

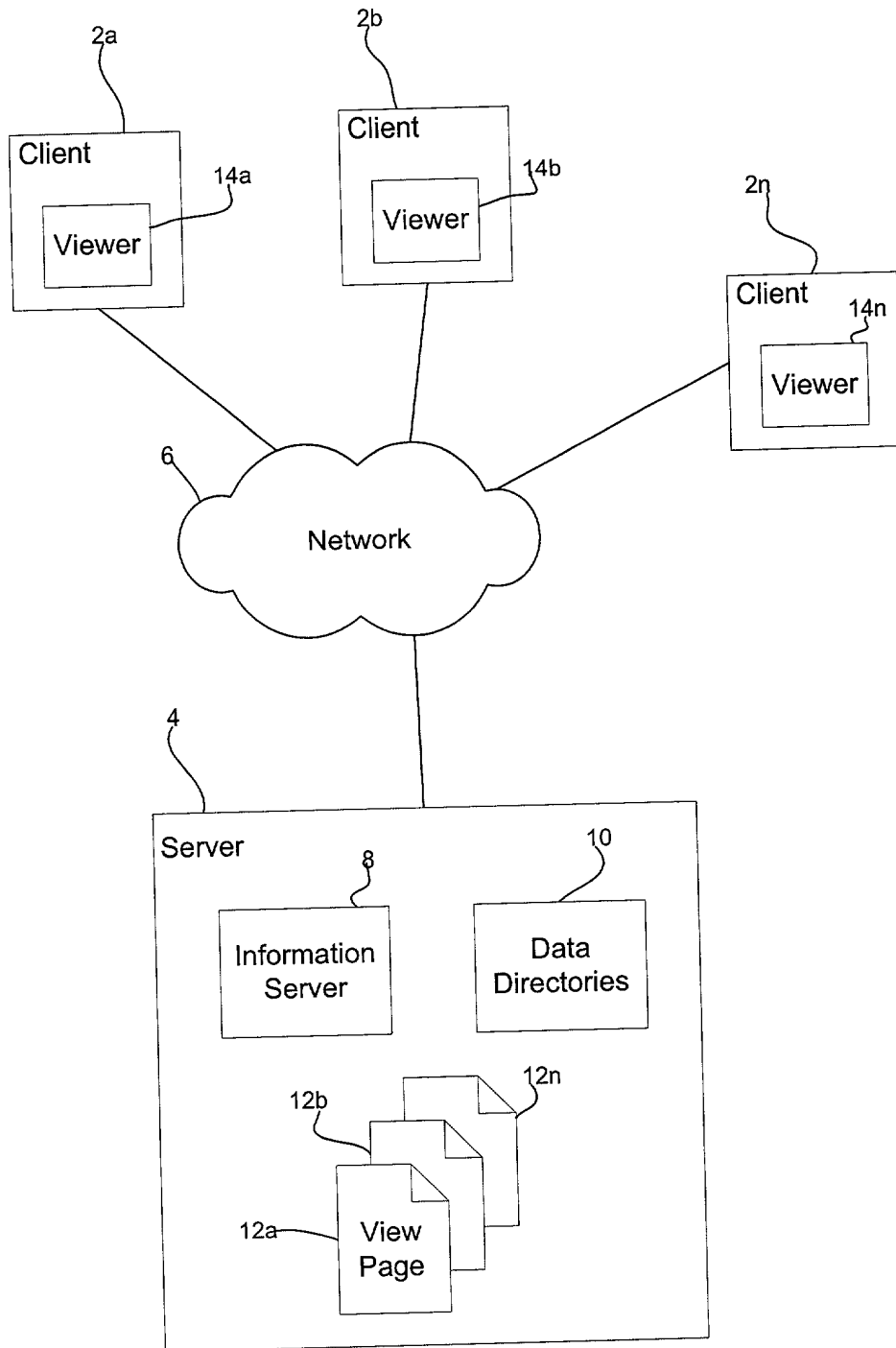
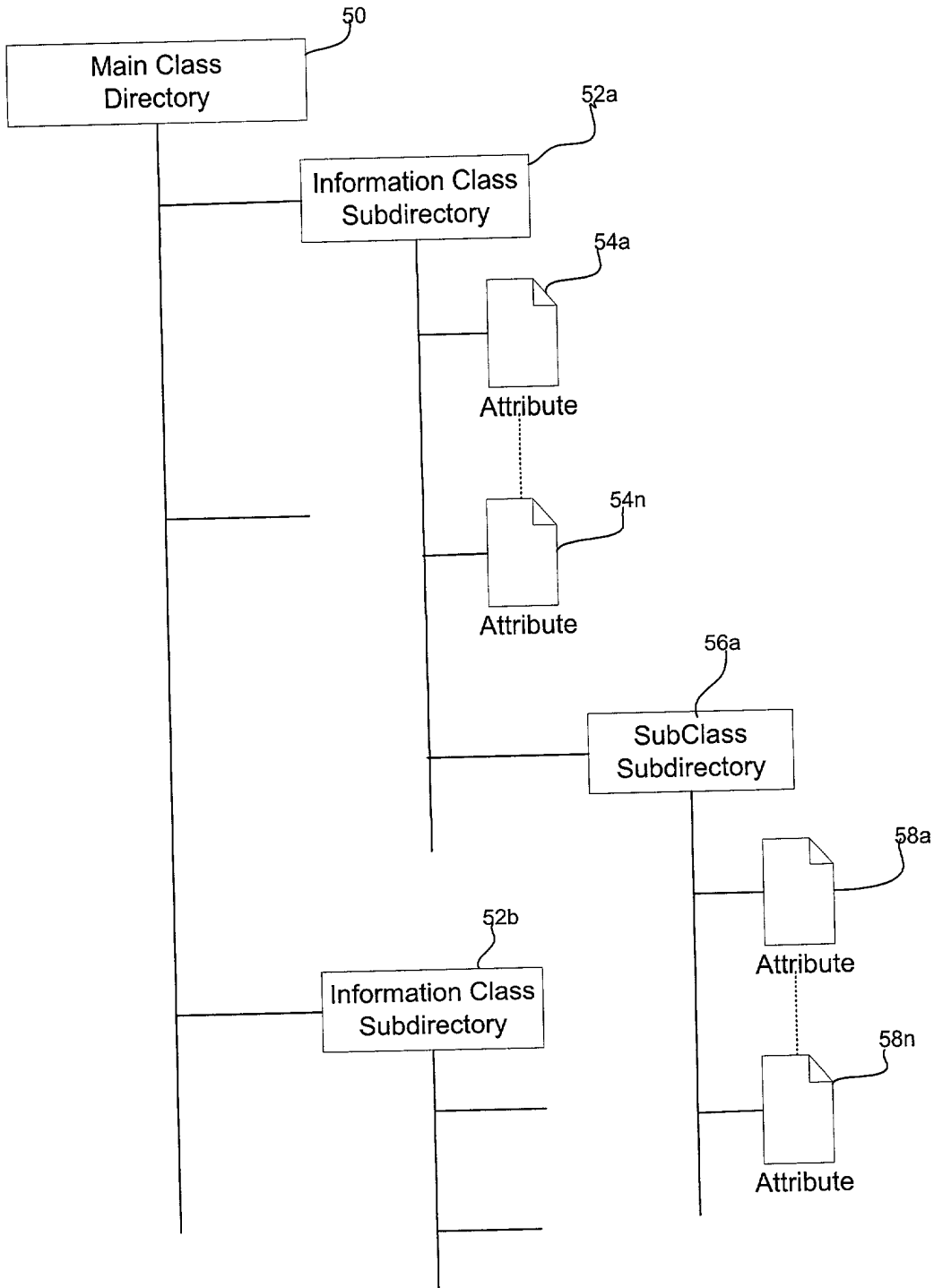

FIG. 1

FIG. 2



TOP CASE

FIG. 3a

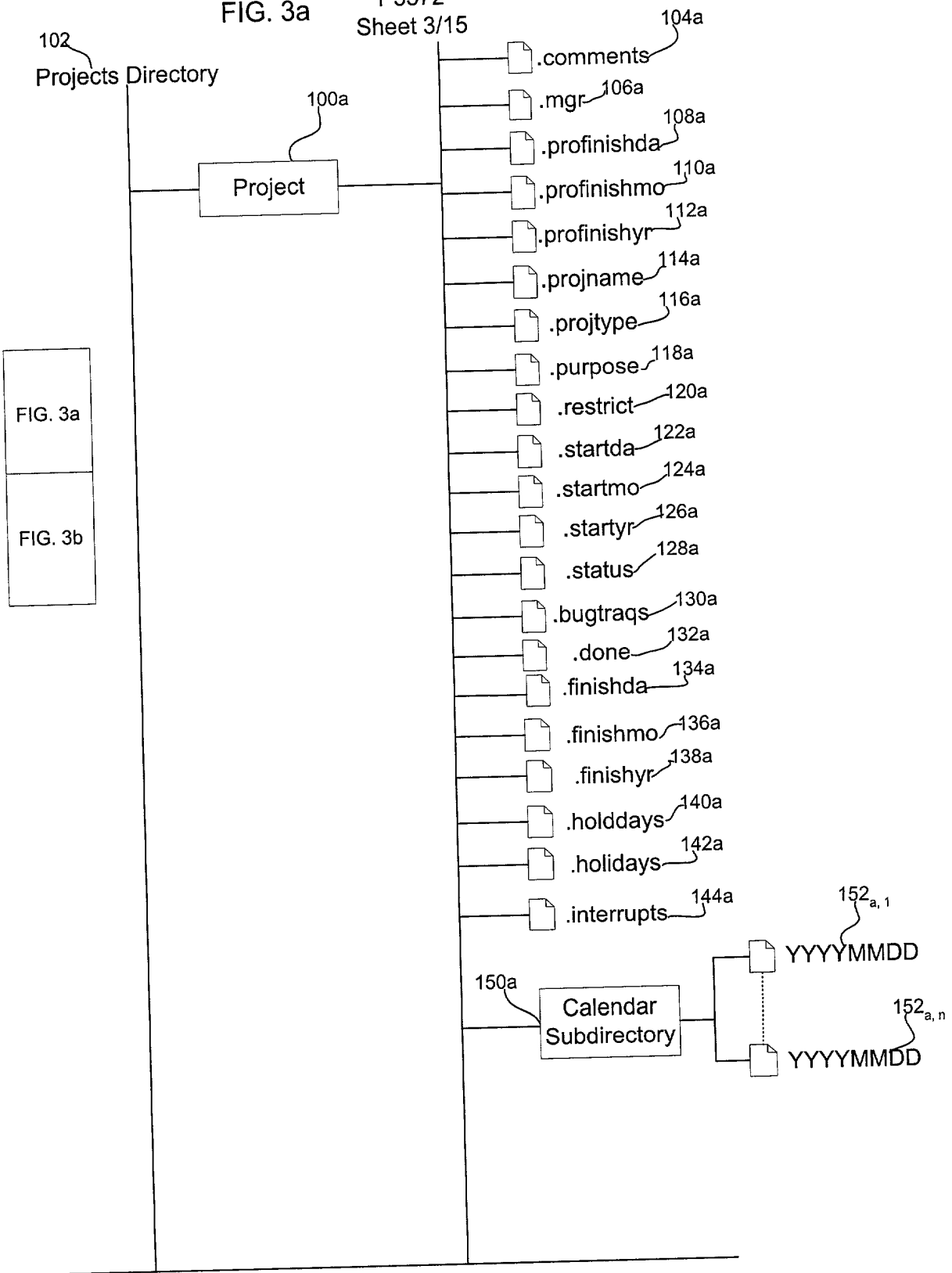
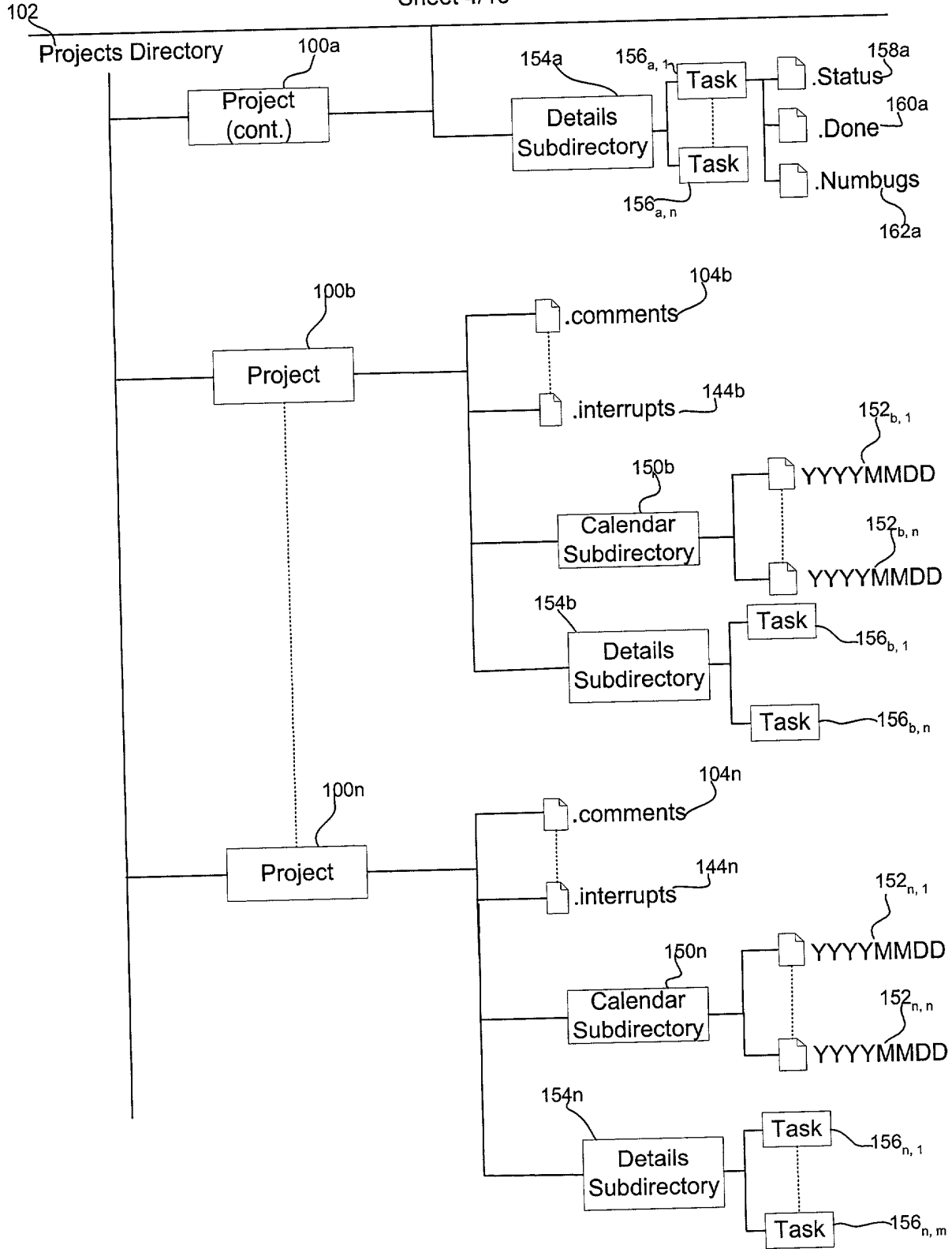

FIG. 3a

FIG. 3b

P. M. Schein

FIG. 3b



FOR RELEASE

FIG. 4

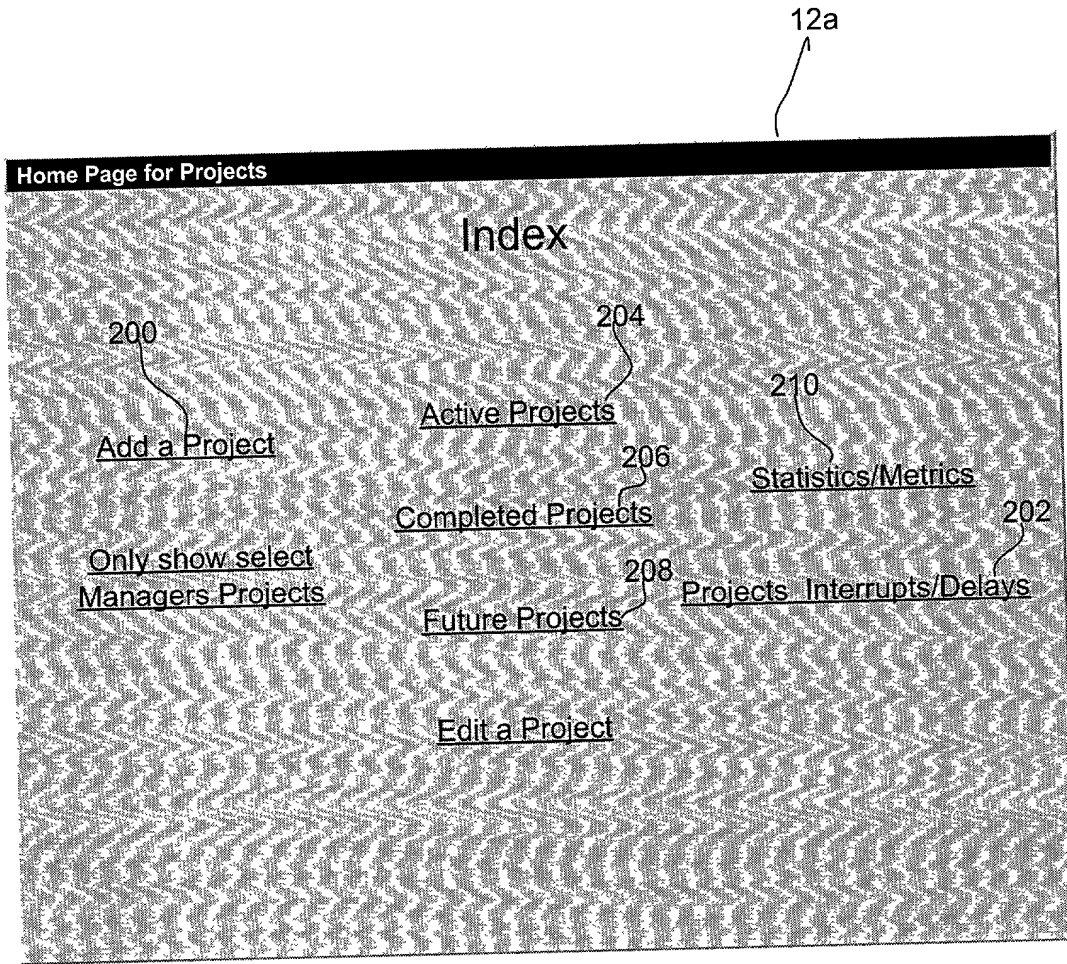

"FOOT" 683E2660

FIG. 5

12b

The screenshot shows a window titled "Adding a Project" with the following elements:

- Project Name:** Input field (250)
- Project Type:** Input field (252)
- Purpose:** Input field (254)
- Manager:** Input field (256)
- Date Section:** Labels for Day (258), Month (260), and Year (262) above the start date fields.
- Project Start:** Three dropdown menus for Day, Month, and Year.
- Project Completion:** Three dropdown menus for Day (264), Month (266), and Year (268).
- Status:** A dropdown menu (270) with a list of options:
 - Green - On schedule, no problems
 - Yellow - Behind schedule, but recoverable, moderate bugs
 - Red - Too far behind to recover, high impact bugs
 - Suspended - Project not Active
 - White - Project has not started
 - Complete - Project complete
- Comments:** A large text area (272).
- Restrict Viewing:** A checkbox (274) labeled "Yes".
- SUBMIT CHANGES:** A button (278).

10001" 635E2600

FIG. 6

12d

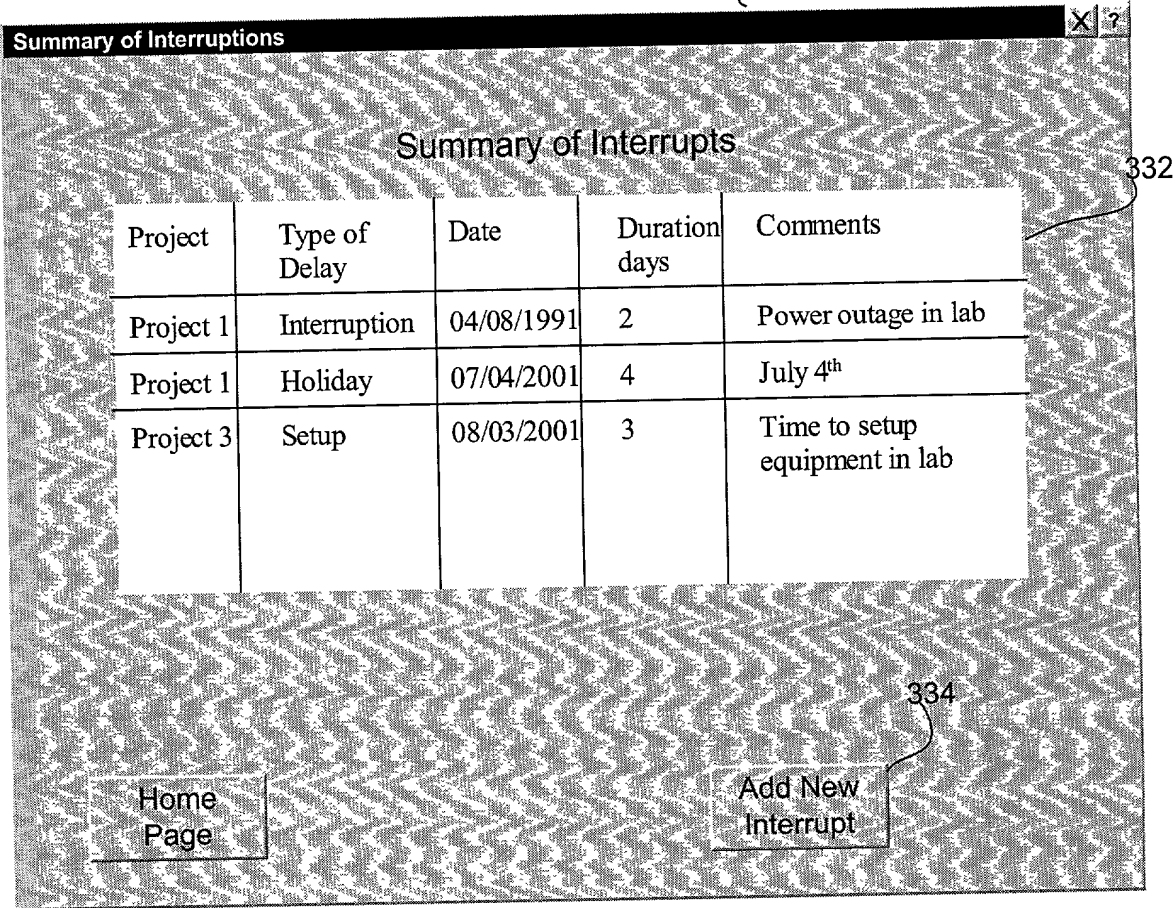
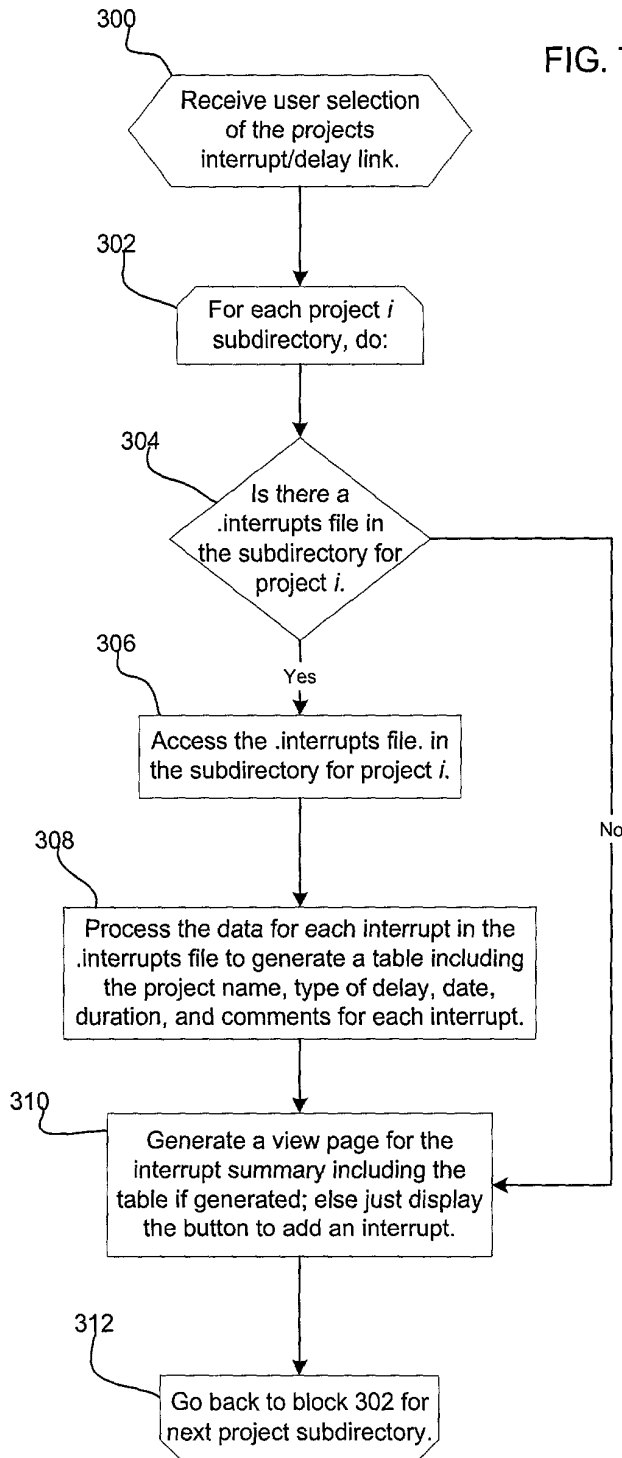

FIG. 6 OF P5572.DOC

FIG. 7



FOR "BOT" 6366666

FIG. 8a

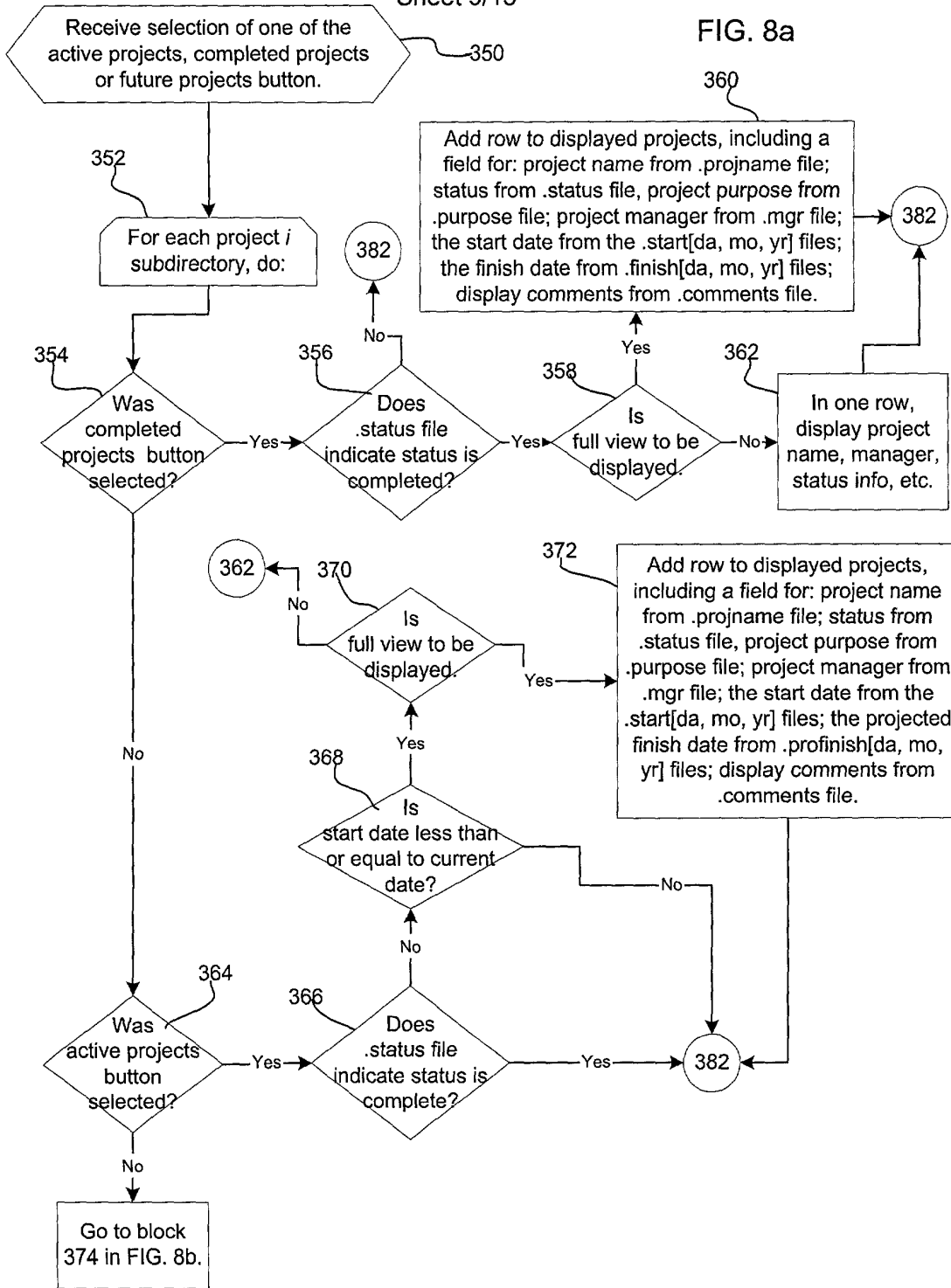

Copyright © 2003 by P. M. Schein

FIG. 8b

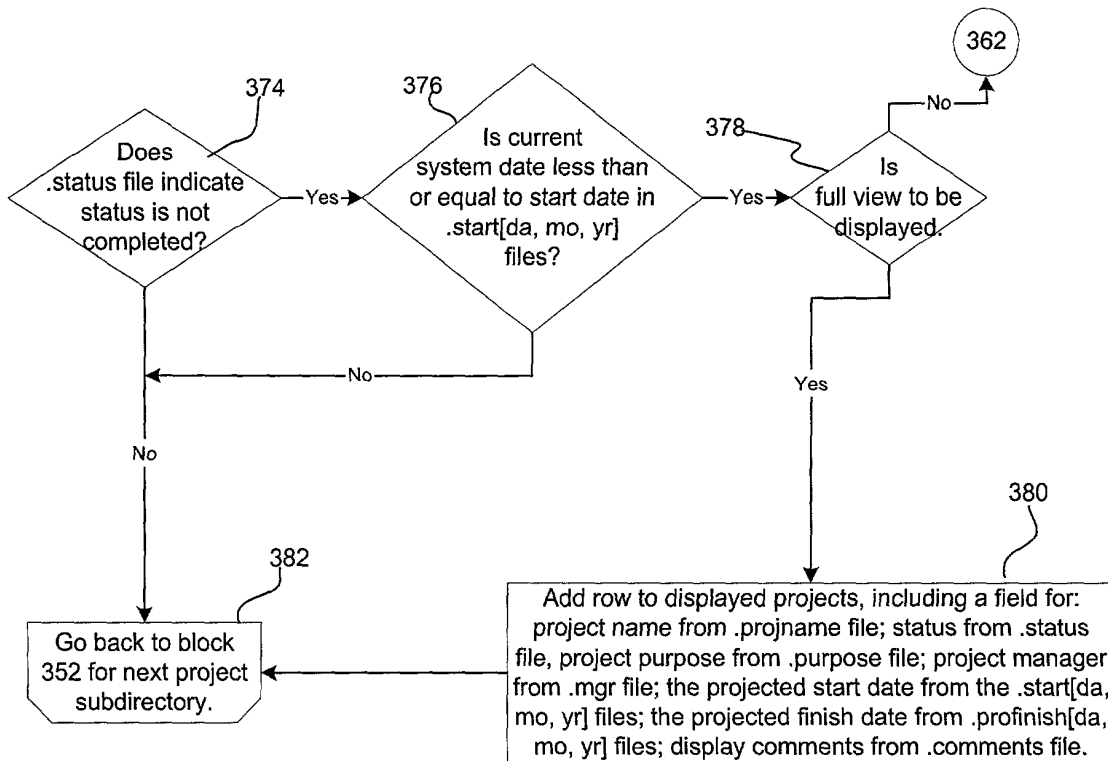

"FIG. 8b" SCHEIN

FIG. 9

12e

Completed Projects

Project	Status	Comments
Project 1 <u>Edit</u> <u>Calendar Status</u>	Completed <u>Details</u>	Comments for test project 1 <hr/> Project Purpose: Design software <hr/> Project Manager: Joe Smith Date Started: 03/01/1999 Date Finished: 05/03/2000
Project 2 <u>Edit</u> <u>Calendar Status</u> <u>Details</u>	Completed <u>Details</u>	Comments for test project 2 <hr/> Project Purpose: Design software <hr/> Project Manager: Joe Jones Date Started: 05/01/2000 Date Finished: 04/03/2001

388

384

386

FOOT 582260

FIG. 10

12f

Details View

Task Project Status

Task Area (Click on Task Name to Edit)	Task On Time	% Done	Bugs Filed	Comments
Entrance Criteria Met	On schedule	33	3	On time, bob is handling
Systems and Hardware setup	behind schedule	5	1	Late start
Fault Injection testing	Not started	0	0	0

FOOT" 68E260

FIG. 11

12g

Details View

Task Project Status

410 412 414 416

Task Area (Click on Task Name to Edit)	Task On Time	% Done Subtask 1			% Done Subtask 2			Bugs Filed	Comments
		A	B	C	1	2	3		
Entrance Criteria Met	On schedule	35	35	0	0	16	2	3	On time, bob is handling
Systems and Hardware setup	behind schedule	5	5	5	26	45	0	1	Late start
Fault Injection testing	Not started	0	0	0	0	0	0	0	0

FOOTBALL 6662660

FIG. 12

12h

Statistics/Metric Information

Statistics/Metrics

Project	Start Date Finish Date	Days project was interrupted	Days project was active	Number of Holidays while project was active	Days interrupted due to setup	Days interrupted due to management hold	Percent Completed
1	05/01/2001 ??	8	43	3	2	4	20
2	06/02/2000 07/02/2000	3	31	2	1	0	54
5	08/03/2001 ??	0	12	0	0	0	12

FOOT 58260

FIG. 13

12i

Calendar Status of Project

Project Calendar for August

Sunday	Monday	Tuesday	Wednesday	Thursday	Friday	Saturday
		01 One day interrupt for vacation day.	02	03	04	05
06	07	08	9 Added interrupt for power delay	10	11	12

440

FOOTBALL